

Medical AC-DC Open Frame Power Supply

12V 250W with 5V/0.5A Standby / MDS-250A series



MDS-250A Series

Highlights & Features

- Safety Approvals to IEC 60601-1 3.1rd ed. & IEC 62368-1
- Compliant with IEC 60601-1-2 4th Ed. Requirements
- Up to 150 Watt Convection
- Up to 500 K Hrs MTBF
- Suited for Type BF Medical Products
- 2 × MOPP isolation



Safety Standards



CB Certified for worldwide use

Model Number: MDS-250A
Unit Weight: 405 g (MDS-250APB12)
 610 g (MDS-250ADB12)

Dimensions (W x L x H):
 76.5 x 127.3 x 36.1 mm 3 x 5 x 1.4 inch (MDS-250APB12)
 88.9 x 140.0 x 44.4 mm 3.5 x 5.5 x 1.75 inch (MDS-250ADB12)

General Description

Delta's new MDS-250APB12 open frame design offers a high energy density (12 Watts/in³) 3x5 inch design for Type BF patient access medical products. With operating parameters of 90 to 264 Vac universal input voltage, temperatures of -10 to +70 degrees centigrade, and altitudes of up to 5000 meters (16,400 feet), the design is well suited for a variety of both medical and non-medical applications. Other features include input surge of 300 Vac, low leakage current, no-load input power < 0.5 Watt, and 500K hour MTBF. This product is certified for EMC standards EN 55011 for industrial, scientific and medical (ISM) radio-frequency equipment, and EN 55022 for Industrial Technology Equipment (ITE) radio-frequency equipment. In addition, only recognized Japanese capacitors are used to ensure long product life.

An enhanced feature set, includes a 5 Volt/0.5 amp standby output, remote on/off, remote sense, and a power good signal that are included as part of the standard product.

The design, which has protection against shock compliant with 2XMOPP and Type BF requirements, has both medical (with risk report available), and ITE safety approvals, including cURus(US&Canada) /TUV/GB(China); plus, CB certificates with all national deviations. Full compliance with RoHS Directive 2011/65/EU for environmental protection is included. The unit comes in a standard 3x5 inch footprint, with height suitable for 1U applications. Robust terminals are capable of multiple connections of the main output to the end product. Enclosed assembly is available option.

Model Information (All with 5V/0.5A standby available)

| Model Number | Input Voltage | Output Voltage | Convection Current Output | Forced Air Current Output |
|----------------------------------|---------------|----------------|---------------------------|----------------------------------|
| MDS-250APB12 AA | 90-264Vac | 12Vdc | 0-12.5A | 0-20.84A (with 10CFM forced air) |
| MDS-250ADB12 AA (Enclosed cover) | 90-264Vac | 12Vdc | 0-11.25A | 0-20.84A (with 10CFM forced air) |

| | | | | | | |
|----------------------------|--|-------------------|--|---------------------------------|---------------------------|--------------------------------|
| MDS | 250 | A | □ | B | 12 | □□ |
| Delta Medical Power Supply | Max wattage in the product series. 250 →250W | Family Code A ~ Z | Product Type P: Open Frame D: Enclosed | Input Type Code B: 3pin Class I | Output Voltage 12 for 12V | Revision code, Refer to page.9 |

Medical AC-DC Open Frame Power Supply

12V 250W with 5V/0.5A Standby / MDS-250A series



Specifications

Input Ratings / Characteristics

| | |
|---|--|
| Nominal Input Voltage | 100-240Vac |
| Input Voltage Range | 90-264Vac |
| Nominal Input Frequency | 50-60Hz |
| Input Frequency Range | 47-63Hz |
| Input Current (max) | 3.5A |
| Input Surge Voltage (max) | 300Vac for 100ms |
| Full load Efficiency (typ.) | 89.45% @ 115Vac/60Hz 90.50% @ 230Vac/50Hz, Reference Fig.1 |
| Standby Power (max) | 0.5W (Inhibit signal high, 24 volt turned off) @ 115Vac/60Hz, 230Vac/50Hz |
| Inrush Current (max) | 40A @ 230Vac, cold start |
| Input-PE(protective earth) leakage current (max) | 0.1mA @ NC ¹⁾ , 0.3mA @ SFC ¹⁾ |
| Output-PE(protective earth) leakage current for Type BF application (max) | 0.1mA @ NC ¹⁾ , 0.5mA @ SFC ¹⁾ |
| Power Factor (min) | 0.9 @ 115V/50Hz, 230V/50Hz, full load |

1) NC: normal condition, SFC: single fault condition

Leakage Current

| Input-PE Leakage Current | 100Vac/60Hz (Typ) | 264Vac/60Hz(Typ) | Delta Limit | IEC60601-1 Limit |
|---|-------------------|------------------|-------------|------------------|
| Normal Condition | 17.5uA | 43.5uA | 100uA max | 5000uA max |
| Single Fault Condition | 32.9uA | 90.7uA | 300uA max | 10000uA max |
| Output-PE Leakage Current for Type BF application | | | | |
| Normal Condition | 28.5uA | 86.7uA | 100uA max | 100uA max |
| Single Fault Condition | 42.9uA | 128.6uA | 500uA max | 500uA max |

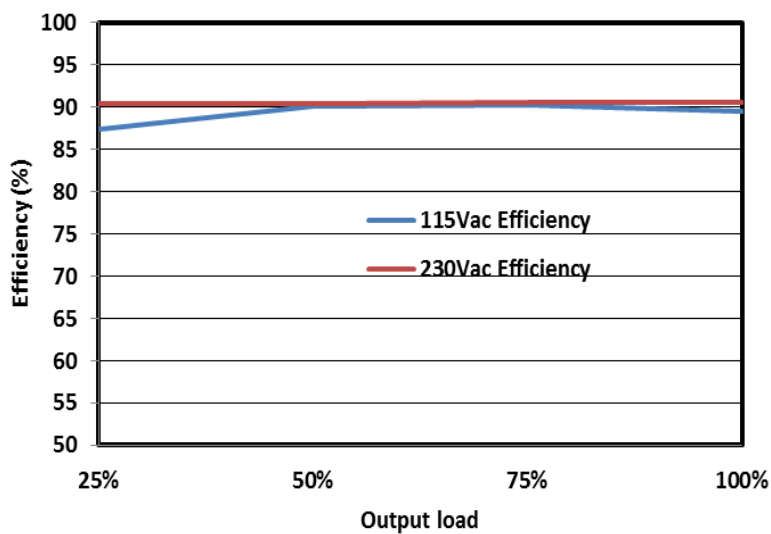

Fig.1 Efficiency versus output load

Medical AC-DC Open Frame Power Supply

12V 250W with 5V/0.5A Standby / MDS-250A series



Output Ratings / Characteristics (Main Output)

| | |
|---|--|
| Nominal Output Voltage (Vrated) | 12V |
| Total Regulation | ± 3% |
| Output Power | 250W 10CFM air, up to 150W convection air |
| Line Regulation (max) | ±0.5% |
| Load Regulation (max) | ±1% |
| Ripple & Noise (typ.) | 1% pk-pk Vrated@250W load, (Refer to Fig. 2 & Fig. 3) |
| Start-up Time (max) | 2000ms @ 115Vac |
| Hold-up Time (min) | 10ms @ 100Vac and 115Vac, with 250W load 20ms @ 100Vac and 115Vac, with 130W load |
| Dynamic Response (Overshoot & Undershoot O/P Voltage) | ± 5% @ with 50-100% load change |
| Capacitive load (max) | 1500uF |
| Rise time (max) | 100ms |
| Remote Sense | Up to 500mV compensation for voltage drop across external wire connections to load. Short and reverse connection protected. |

Output Ratings / Characteristics—Standby Output

| | |
|---|--------------------------------------|
| Nominal Output Voltage of standby output (Vrated) | 5V |
| Total Regulation of standby output | ± 3% |
| Ripple & Noise of standby output | 100mV max (Refer to Fig. 2 & Fig. 3) |

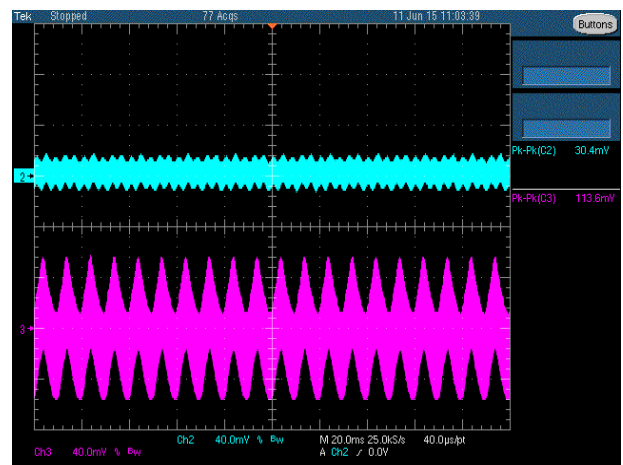
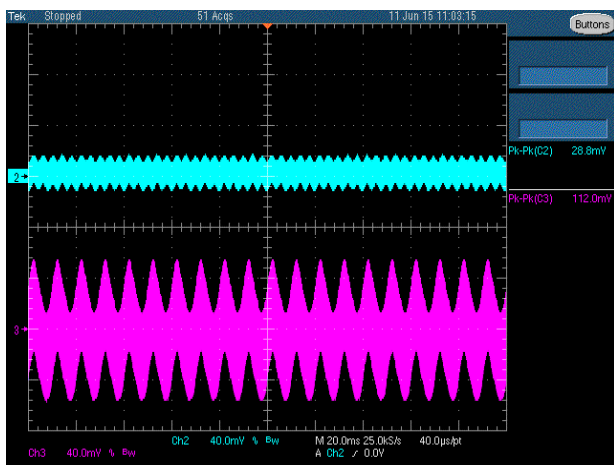

(a) 115V (measured value=112.0mV for 12V and 28.8mV for 5V) (b) 230V(measured value=113.6mV for 12V and 30.4mV for 5V)

Fig.2 Ripple & Noise example, 20MHz BW

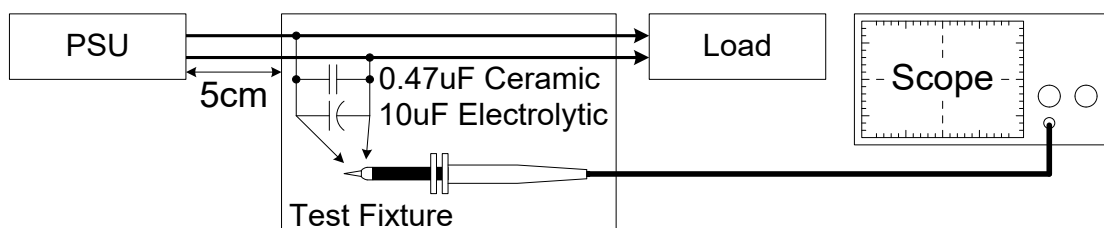

Fig. 3 Ripple & Noise measurement circuit

Medical AC-DC Open Frame Power Supply

12V 250W with 5V/0.5A Standby / MDS-250A series



Mechanical

| | |
|-----------------------|---|
| Case Cover | Enclosed, refer to drawings on pages 8 and 9 |
| Dimensions(W x L x H) | 76.5x127.3x36.1mm 3x5x1.4 inch (MDS-250APB12) 88.9x140.0x45.0mm 3.5x5.512x1.772inch (MDS-250ADB12) |
| Unit Weight | 405g (0.89 lb.) (MDS-250APB12) 610g (1.34 lb.) (MDS-250ADB12) |

Environment

| | | |
|-----------------------------|---|---|
| Surrounding Air Temperature | Operating | Absolute Maximum/Minimum Rating. -10°C to +70°C. Linearly derate from 100% load at 50°C to 45 ~ 50% load at 70°C Note: see power de-rating curves below |
| | Storage | -40°C to +85°C |
| Operating Humidity | 5-95% RH (Non-Condensing) | |
| Operating Altitude | 5,000 meters (16,400 feet or 50kPa) | |
| Non-Operating Altitude | 5,000 meters (16,400 feet or 50kPa) | |
| Shock Test (Non-Operating) | 50G, 11ms, 3 shocks for each direction | |
| Vibration (Operating) | 5-500Hz, 2Grms, 15 minute for each three axis | |

Power De-rating curves

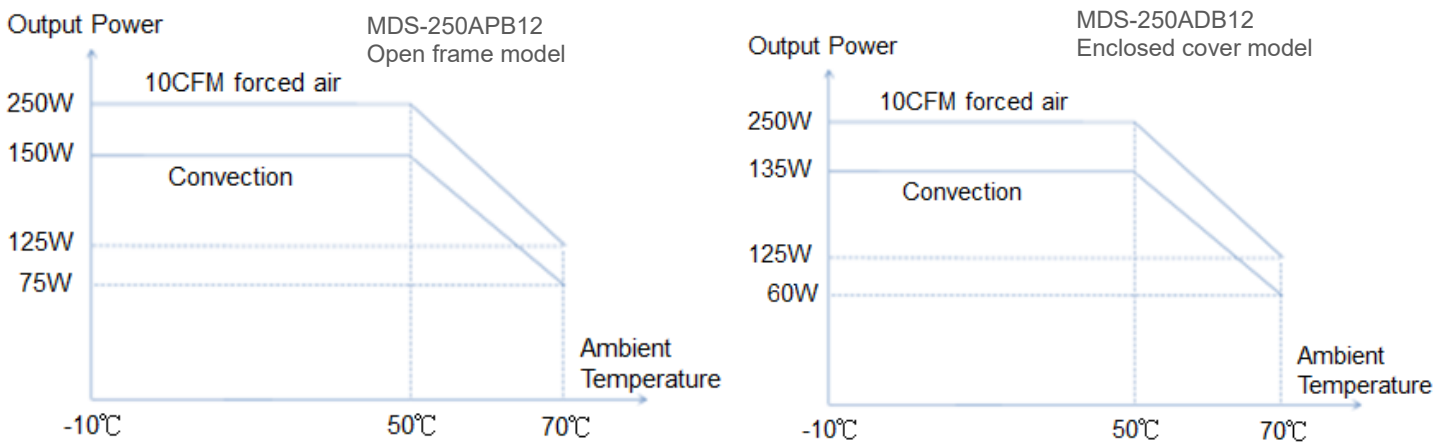

Load De-rating Fixture and Test Setup. Fan is DELTA Part Number AFB0512HHD.

MDS-250APB12 Open frame model

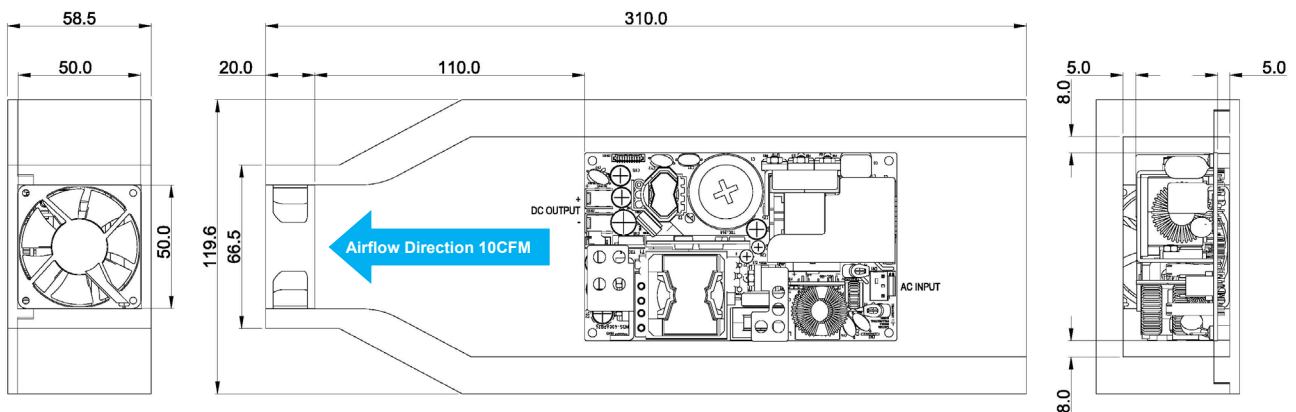

Medical AC-DC Open Frame Power Supply

12V 250W with 5V/0.5A Standby / MDS-250A series



MDS-250ADB12 Enclosed cover model

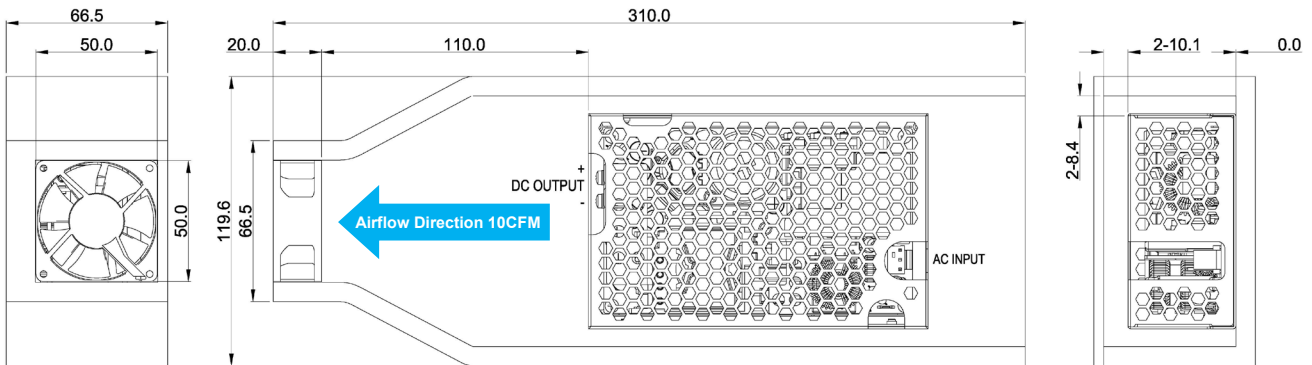

Protections (for both 12Volt and 5Volt Standby outputs, unless otherwise indicated)

| | |
|--------------------------------|---|
| Overvoltage (max) | Main output 125% of rated voltage, Latch Mode Standby Output 125% of rated voltage, Latch Mode |
| Over load / Over current (max) | Main output 160% of rated current Standby Output 1.06A max Hiccup Mode(Non-Latching, Auto-Recovery) |
| Over Temperature | Latch Mode for main output |
| Short Circuit | Hiccup Mode, (Non-Latching, Auto-Recovery) |

Reliability Data

| | | |
|---|---------------------|-------------------------------------|
| MTBF(Minimum) at 115Vac, 150W, 35 °C | Convection Air Flow | 500 Khrs based on Telecordia SR-332 |
| Operating life(Minimum) at 115Vac, 150W, 25°C | Convection Air Flow | 26,280 hrs |

Safety Standards / Directives

| | | |
|--------------------|--|--------------------------------------|
| Medical Safety | IEC60601-1 2 nd , 3 rd and 3.1 rd edition CB report IEC60601-1 edition 3.1 rd (2012), EN60601-1 (2006) + A11 + A1 + A12, CAN/CSA-C22.2 NO. 60601-1:14, ANSI/AAMI ES60601-1:2005/(R)2012 | |
| ITE Safety | IEC60950-1, IEC62368-1 CB report TUV60950-1 UL60950-1+CAN/CSA60950-1 GB4943.1-2011, GB9254-2008, GB17625.1-2003 | |
| CE | MDD Directive 93/42/EEC | |
| Environmental | RoHS Directive 2011/65/EU Compliant | |
| Galvanic Isolation | Input to/Output (2XMOPP) | 4000 Vac |
| | Input to/Ground(1XMOPP) | 1500 Vac ¹⁾ |
| | Output to/Ground(1XMOPP) | 1500 Vac (Type BF application rated) |

1) PSU can support PoE applications with Primary to FG 2500Vac test.



Medical AC-DC Open Frame Power Supply

12V 250W with 5V/0.5A Standby / MDS-250A series



EMC (Compliant with IEC-60601-1-2 4th Ed. requirements)

| | | |
|-----------------------------------|---------------|---|
| EMC / Emissions | | EN55011/EN55022,FCC Title 47:Class B |
| Harmonic Current Emissions | IEC61000-3-2 | Meet Class D limit |
| Immunity to | | |
| Voltage Flicker | IEC61000-3-3 | |
| Electrostatic Discharge | IEC61000-4-2 | Level 4 Criteria A ¹⁾ Air Discharge: 15kV Contact Discharge: 8kV |
| Radiated Field | IEC61000-4-3 | Criteria A ¹⁾ 80MHz-2700MHz, 10V/m AM modulation 385MHz-5785MHz, 28V/m Pulse mode and other modulation |
| Electrical Fast Transient / Burst | IEC61000-4-4 | Level 3 Criteria A ¹⁾ :2kV |
| Surge | IEC61000-4-5 | Level 3 Criteria A ¹⁾ Common Mode ³⁾ : 2kV Differential Mode ⁴⁾ : 1kV |
| Conducted | IEC61000-4-6 | Level 2 Criteria A ¹⁾ 150kHz-80MHz, 3Vrms, 6Vrms at ISM bands and Amateur radio bands |
| Power Frequency Magnetic Fields | IEC61000-4-8 | Criteria A ¹⁾ Magnetic field strength 30A/m |
| Voltage Dips | IEC61000-4-11 | Criteria A ¹⁾ 0% U _r , 0.5 cycle (10ms) , 0°/45°/90°/135°/180°/225°/270°/315°/360° Criteria B ²⁾ (Criteria A ¹⁾ with 130W load) 0% U _r , 1 cycle (20ms), 0° Criteria B ²⁾ 70% U _r , 25 cycle (500ms), 0° Criteria B ²⁾ 0% U _r , 250 cycle (5000ms), 0° |

1) Criteria A: Normal performance within the specification limits

2) Criteria B: Output out of regulation, or shuts down during test. Automatically restore to normal operation after test.

3) Asymmetrical: Common mode (Line to earth)

4) Symmetrical: Differential mode (Line to line)

5) Unless otherwise noted, requirements apply at 250 watt output load

Medical AC-DC Open Frame Power Supply

12V 250W with 5V/0.5A Standby / MDS-250A series



Dimensions

Open Frame Mechanical drawing (MDS-250APB12)

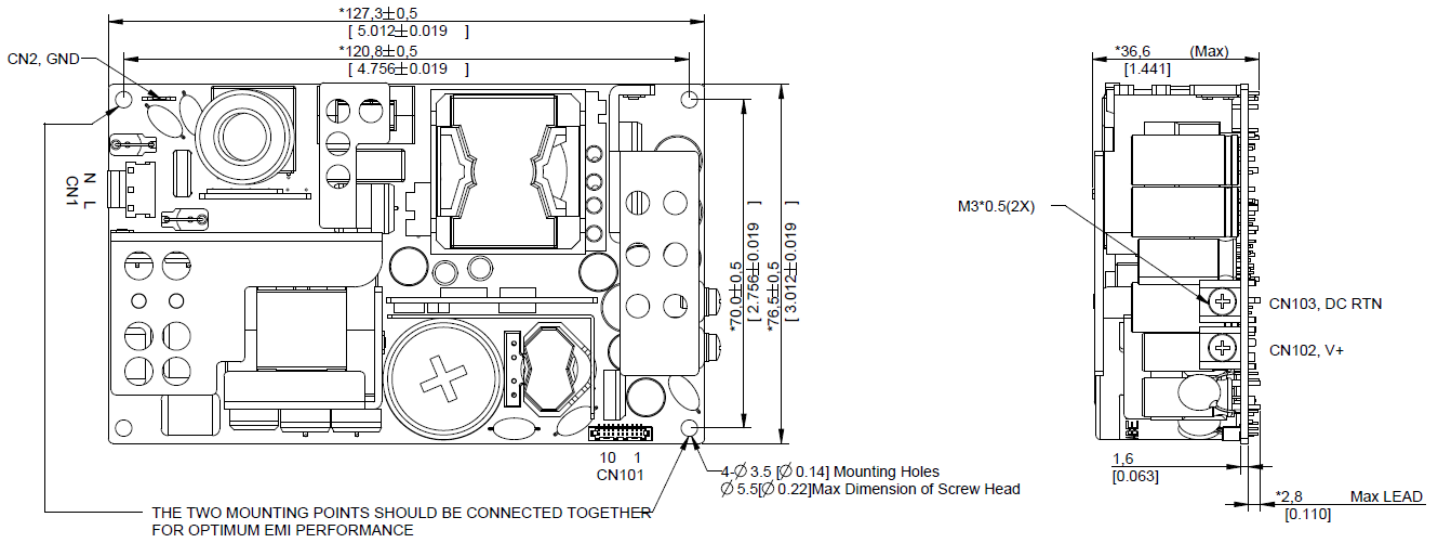

Medical AC-DC Open Frame Power Supply

12V 250W with 5V/0.5A Standby / MDS-250A series



Covered Enclosure Mechanical drawing (MDS-250ADB12)

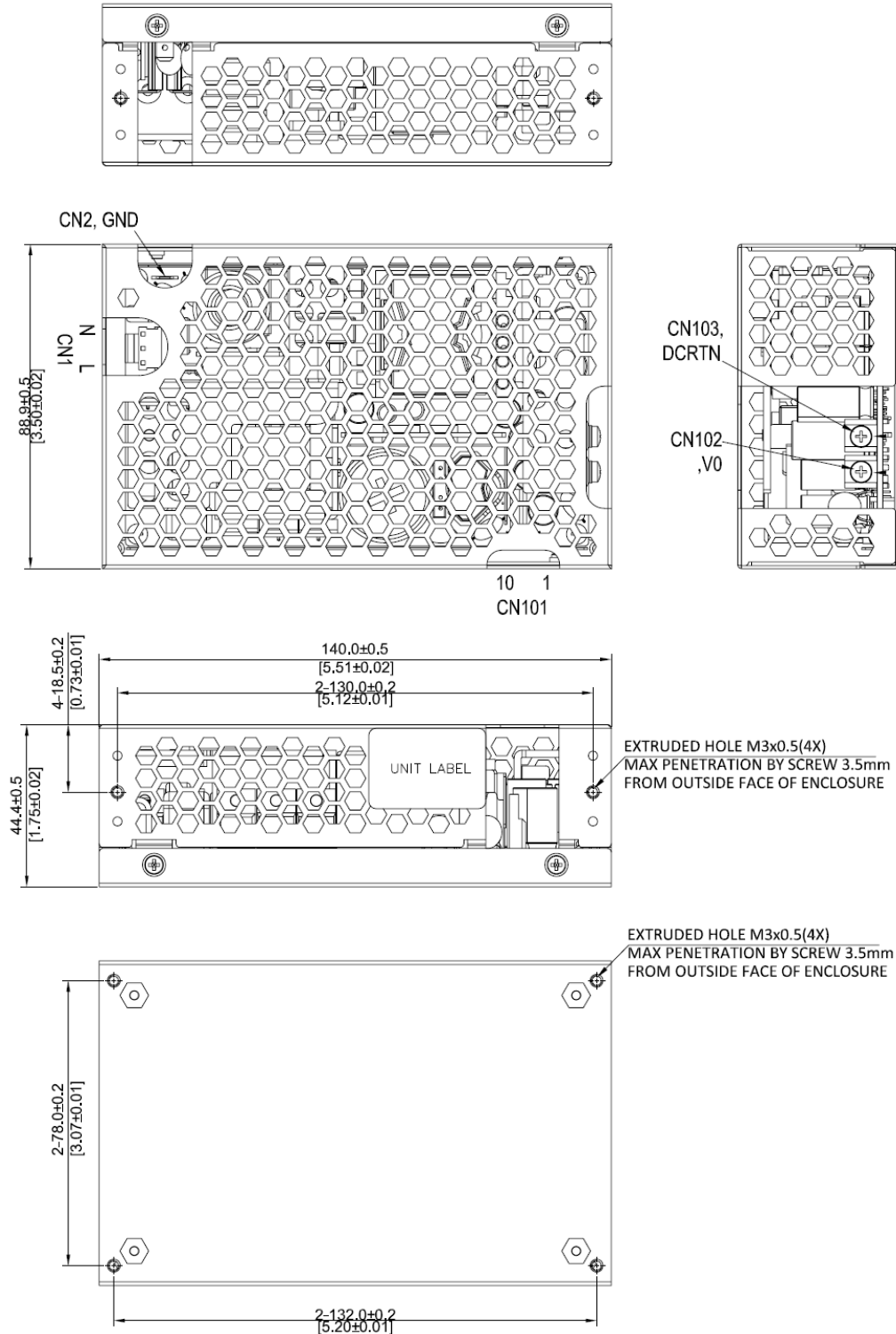

- Notes**
- Dimensions are in mm(inches)
 - There are two locations where assembled power supply is connected to the customer's product
 - Bottom mounting, use (4X) M3 screws to affix assembled power supply to product's enclosure. Extruded hole with thread must be withstand 9Kgf.cm (7.81lb-in) min. Maximum allowed screw penetration is 3.5mm (0.138 inch).
 - Side mounting, use (2X) M3 screws to affix one side of assembled power supply to the product's enclosure. Extruded hole with thread must be withstand 9Kgf.cm (7.81lb-in) min. Maximum allowed screw penetration is 3.5mm (0.138 inch).



Medical AC-DC Open Frame Power Supply

12V 250W with 5V/0.5A Standby / MDS-250A series



- CN1 mates with Molex housing 26-03-4030 and Molex series 6838 crimp terminals. Input Line can also be connected to Input Neutral, and Input Neutral can be connected to Input Line.
- CN102 & CN103(Output Connector) : Cross recessed pan head screws M3X0.5x10, with spring washers and flat washers, force required to tighten the screws is 7~8kgf.cm(6.1~7.0inch-lb)
- CN2 : PINGOOD JP-13T or equivalent mates with KST:DFNYD1-187 or other applicable connectors.
- CN101 mates with Molex housing 1041421000 and Molex series 104539-8002 crimp terminals.

| Control and STANDBY connector CN101 | |
|-------------------------------------|---------------------------------|
| Pin 1 | Remote sense + |
| Pin 2 | Remote sense - |
| Pin 3 | Power Good + |
| Pin 4 | Power Good -(DC RTN) |
| Pin 5 | Remote ON_OFF/INHIBIT + |
| Pin 6 | Remote ON_OFF/INHIBIT -(DC RTN) |
| Pin 7 | 5V Standby |
| Pin 8 | DC RTN |
| Pin 9 | 5V Standby |
| Pin 10 | DC RTN |

For optimum EMI performance, the two mounting points shown in open frame mechanical drawing need to be connected together to system earth case. Protective bonding conductor from the end product protective earth terminal can be tied to CN2 for open frame model. CN2 of enclosed model is connected to the cover by assembly screws already; in this case, system protective earth connection can be connected to the cover or to CN2

| MDS-250AXB12 □□ | |
|-----------------|---|
| <u>AA</u> | Delta Standard |
| <u>AB</u> | A mating connector with Molex housing 1041421000 and Molex terminals 1045398002, with jumper wire between pins 5 and 6, will be inserted into CN101. This will allow the power supply to turn on, without user intervention, upon the application of input AC voltage Due to presence of mating connector, external connections cannot be made to pins 1-10 of CN101. |

Medical AC-DC Open Frame Power Supply

12V 250W with 5V/0.5A Standby / MDS-250A series



Functions

Start-up Time

The time required for the output voltage to reach 90% of its final steady state value, after the input voltage is applied.

Rise Time

The time required for the output voltage to change from 10% to 90% of its final steady state value.

Hold-up Time

Time between the collapse of the AC input voltage, and the output falling to 90% of its steady state value.

■ Graph illustrating the Start-up Time, Rise Time, and Hold-up Time

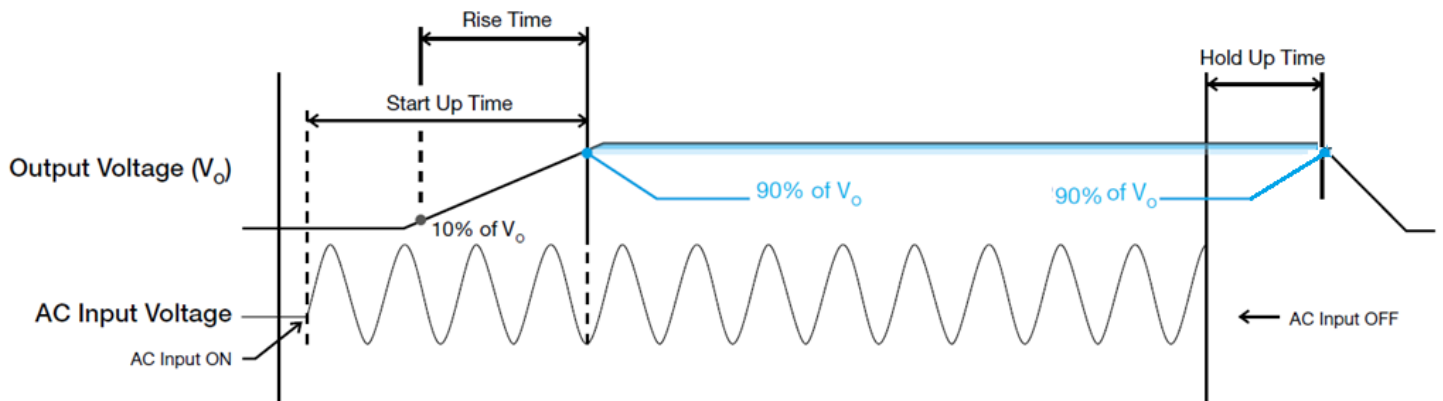

Medical AC-DC Open Frame Power Supply

12V 250W with 5V/0.5A Standby / MDS-250A series



Dynamic Response(12 Volt Output)

The power supply output voltage will remain within $\pm 5\%$ of its steady state value, when subjected to a dynamic load 50 to 100% of its rated current.

■ 50 to 100% Load

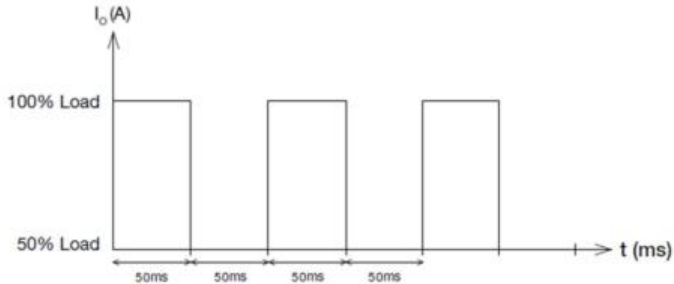

Inrush Current

Inrush current is the input current that occurs when the input voltage is first applied. For AC input voltages, the maximum peak value of inrush current will occur during the first half cycle of the applied AC voltage. This peak value decreases exponentially during subsequent cycles of AC voltage.

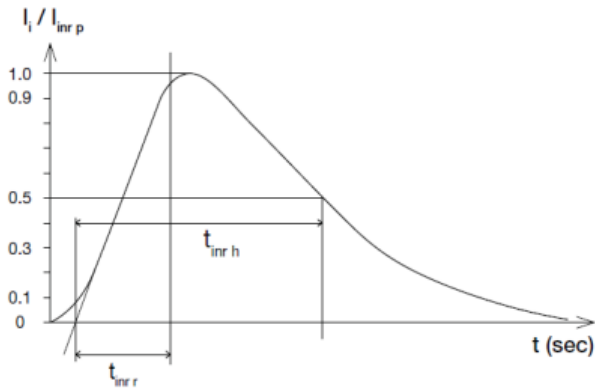

Overvoltage Protection

The power supply's overvoltage circuit will be activated when its internal feedback circuit fails. The output voltage shall not exceed its specifications defined on Page 5 under "Protections". Power supply will latch off, and require removal/re-application of input AC voltage in order to restart.

Overload & Over current Protections

The power supply's Overload (OLP) and Over current (OCP) Protections will be activated before the 12 volt outputs' current exceeds 160% of I_O (Max load). Upon such an occurrence, VO will start to drop. Once the power supply has reached its maximum power limit, the protection will be activated and the power supply will go into "Hiccup mode" (Auto-Recovery). The power supply will recover once the fault condition causing the OLP and OCP is removed and IO is back within the specified limit. For the standby output, the performance is the same, with the exception that the protection will be activated before the output current exceeds 1.06 amps.

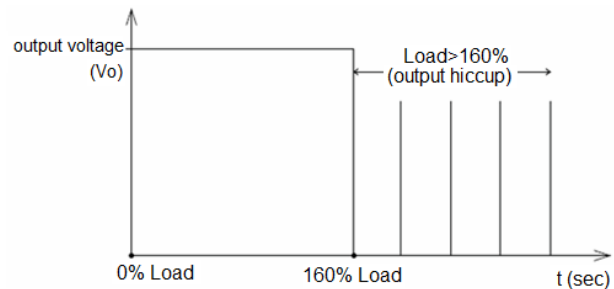

Additionally, if the 12 Volts' lout is $>100\%$; but $<160\%$ for a prolonged period of time (depending on the load), the Over Temperature Protection (OTP) will be activated due to high temperature on critical components. The power supply will then go into latch mode.

Short Circuit Protection

The power supply's output OLP/OCP function also provides protection against short circuits. When a short circuit is applied, the output current will operate in "Hiccup mode", as shown in the illustration in the OLP/OCP section on this page. The power supply will return to normal operation after the short circuit is removed.

Over Temperature Protection

As mentioned above, the power supply also has Over Temperature Protection (OTP). This is activated when the overload condition persists for an extended duration and the output current is below the overload trigger point but $>100\%$ load. In the event of a higher operating temperature condition at 100% load, the power supply will run into OTP when the surrounding air temperature is higher than the operating temperature. When activated, the output voltage will go into latch mode until the input voltage is removed; then, reapplied, and the surrounding air temperature drops to its normal operating temperature.

Medical AC-DC Open Frame Power Supply

12V 250W with 5V/0.5A Standby / MDS-250A series



Power Good

Power Good+ pin is an open collector transistor (40V/600mA rating). A resistor (suggested value 10Kohm, 1/8W) can be added between 5V STANDBY pin (or, other available pull-up voltage that is no greater than 30V) and the Power Good+ pin (refer to figure below). Value of pull-up resistor may have to be adjusted, depending on voltage used, and other end-use conditions of the Power Good+ pin connection to the product. When AC input is on, Power Good+ pin will be high. When AC input is off, Power Good+ pin will be low. There will be a minimum of 5 milliseconds (at 150W load) between the time the power good goes to low level, and the time when the output reaches 90% of its rated value.

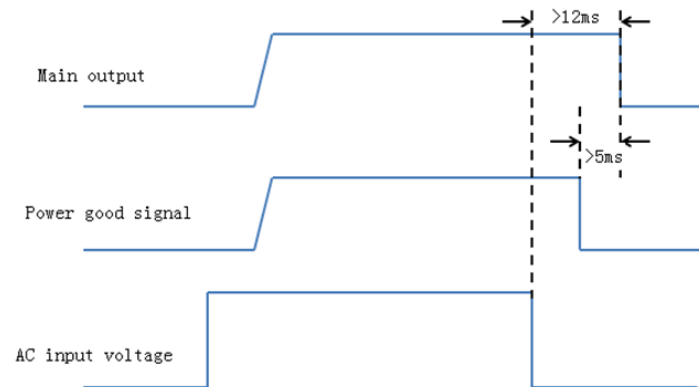
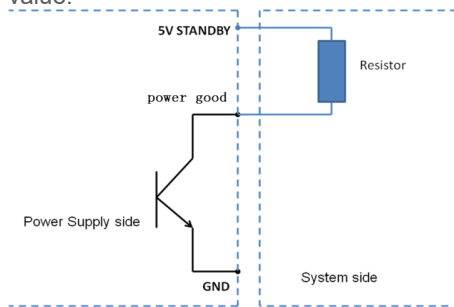

Remote On_Off/ INHIBIT

Remote ON_OFF/ INHIBIT can be used to enable or disable only the main output. When the main output is disabled, the +5V Standby output will continue to operate. This signal can be pulled down to a low level of 0.3 volts, or shorted to DC-Return, in order for the main output to be enabled; and, floated (no connection to the signal), or pulled up to a value greater than or equal to 3 volts, in order to disable the main output

Remote Sense

Remote sense feature can be used to compensate for the extra voltage drop on output wires that are connected from the main output terminals, to the load. With wires connected from the remote sense pins, at the same locations as the wires from the main output, the remote sense function can compensate up to 500mV voltage drop. The power supply will not be damaged if the remote sense pins are shorted, or if a reverse/inverted polarity connection is made to the load

Medical AC-DC Open Frame Power Supply

12V 250W with 5V/0.5A Standby / MDS-250A series



Certificate



All Delta Medical Power products conform to the European directive 2011/65/EU. RoHS is the abbreviation for "Restriction of the use of certain hazardous substances"



Delta has been certified as meeting the requirement of ISO 13485: 2003 and EN ISO 13485:2012 for the design and manufacture of switching power supply and adaptor for medical device.



In addition to a UL Total Certification Program (TCP) approved client laboratory for IEC60950 and IEC60065. Delta also has participated UL Client Test Data Program (CDTP) for IEC 60601

TS Connect AB / Power Outlet
Fagerstagatan 9
163 53 Spånga, Sweden

Phone: +46 8 795 93 10
Mail: sales@power-outlet.com

Web: www.power-outlet.com
Web: www.tsconnect.se